



ModulSensor Pressure

Type MSPST



● Table of Contents

1.	General (Information, Use of product, Knowledge required, Overview, Abbreviations)	3
2.	Other (Maintenance, Accessories, Storage, Disposal)	3
3.	For your safety	4
4.	Starting, operation	5
5.	Trouble shooting	8
6.	Technical data	9

● 1 For information

1.1 For information

Read these operating instructions without fail before installing and starting the pressure transmitter. Keep the operating instructions in a place that is accessible to all users at any time. The following installation and operating instructions have been compiled with great care but it is not feasible to take all possible applications into consideration. These installation and operation instructions should meet the needs of most pressure measurement applications. If questions remain regarding a specific application, please contact the supplier of the device.

With special models please note specifications in the delivery note.

If the serial number gets illegible (e. g. by mechanical damage), the retraceability of the instrument is not possible any more. The pressure sensors, described in this operating manual, are carefully designed and manufactured using state-of-the-art technology. Every component undergoes strict quality inspection in all stages of manufacture.

1.2 Use the products in accordance with the intended use

Use the pressure transmitter to transform the pressure into an electrical signal.

1.3 Knowledge required

Install and start the transmitter only if you are familiar with the relevant regulations and directives of your country and if you have the qualification required. You have to be acquainted with the rules and regulations on measurement and control technology and electric circuits, since this pressure sensor is “electrical equipment” as defined by EN 50178. Depending on the operation conditions of your application you have to have the corresponding knowledge, e.g. of aggressive media.

1.4 Overview

The most important information on the product and for your safety you can get in chapters “Signs, abbreviations” (Chap. 1.5) and “Storage, disposal” (Chap. 2.2), “For your safety” (Chap. 3) and “Starting, operation” (Chap. 4).
Read these chapters in any case.

1.5 Signs, abbreviations



Warning

Warning!

A non-observance can cause injuries to persons and/or can be a dangerous to life.



Attention!

A non-observance can cause a faulty operation of the device or lead to demolition of the device.



Information!

A non-observance can have influence on the operation of the device or cause unintentional reactions of the device.

U+: Positive supply connection

U-: Negative supply connection

● 2 Other

2.1 Maintenance, accessories



The pressure sensors MSPST are maintenance-free.
Have repairs performed by the manufacturer only.
For necessary accessories please contact your supplier.

2.2 Storage, disposal



Warning

When storing or disposing the pressure sensor, take precautions with regard to remaining media in removed pressure sensors. It's recommended to clean the transmitter properly and carefully. Remaining media in the pressure port may be hazardous or toxic.



Disposal

Dispose instrument components and packaging materials in accordance with the respective waste treatment and disposal regulations of the region or country to which the sensor is supplied

● 3 For your safety



Warning

Select the appropriate pressure sensor with regard to scale range, performance and specific measurement conditions prior to installing and starting the instrument.

Observe the relevant national regulations (e. g. standards) and observe the applicable standards and directives for special applications (e. g. with dangerous media such as acetylene, flammable gases or liquids and toxic gases or liquids and with refrigeration plants or compressors).

If you do not observe the appropriate regulation, serious injuries and/or damage can occur!

- **Open pressure connections only after the system is without pressure!**
- Make sure that the pressure sensor is only used within the overload threshold limit all the time.
- Observe the ambient and working conditions outlined in chapter "Technical data" (page 8).
- Observe the technical data for the use of the pressure sensor in connection with aggressive / corrosive media and for the avoidance of mechanical hazards.
- Ensure that the pressure sensor is only operated in accordance with the provisions i. e. as described in the following instructions.
- Do not carry out changes or interferences with the pressure sensor which are not describes in these operating instructions.
- Remove the pressure sensor from service and mark it to prevent it from being used again accidentally, if it becomes damaged or unsafe for operation.
- **Take precautions with regard to remaining media in removed pressure sensors. Remaining media in the pressure sensor port may be hazardous or toxic!**
- Have repairs performed by the manufacturer only.
- Open circuit before removing connector / cover

● 4 Starting, operation

4.1 Function

The MSPST has a pressure connection with internal diaphragm. The pressure prevailing within the application is transformed into a standardised electrical signal through the deflection of the diaphragm, which acts on the sensor element with the power supply fed to the transmitter. This electric signal changes in proportion to the pressure and can be evaluated correspondingly.

4.2 Before mounting



Check if a completely assembled pressure sensor is supplied.

Inspect the pressure sensor for possible damage during transportation. Should there be any obvious damage, inform the transport company and supplier without delay.

Keep the packaging, as it offers optimal protection during transportation.

Ensure that the pressure connection thread and the connection contacts will not be damaged.

4.3 Diaphragm test for your safety

It is necessary that before starting the pressure transmitter you test the diaphragm visually, as this is a **safety-relevant component**.



Warning

Pay attention to any liquid leaking out, for this points to a diaphragm damage.

Use the pressure transmitter only if the diaphragm is undamaged.

Use the pressure transmitter only if it is in a faultless condition as far as the safety-relevant features are concerned.

4.4 Product label (example)

Logo	OD 0-0-0-3-0-0-08X 		
Contact	SN : 774.04/10-4.0-001	Art.Nr.: 1500-00422	
P : 0...20 bar	OUT : 4...20 mA HART	U+ : 1	
Pmax : 0...25 bar	SUP. : 12...40 VDC	U- : 3	
	Date : 14/12	Made in Germany	

OP... : Product code

Pmax : Range maximum

P : Pressure range

U+ : Supply/Loop +

U- : Supply/Loop -

Art.Nr.: Part number

SN : Serial number

Date : Date of QC

OUT : Loop signal

SUP. : Range of voltage

4.5 Mechanical connection

Tools: wrench (flats 27), screw driver

You have to provide for a sealing element, exceptions are instruments with self-sealing threads (e. g. NPT thread).

When mounting the instrument, ensure that the sealing faces of the instrument and the measuring point are clean and undamaged.

Screw in or unscrew the instrument only via the flats using a suitable tool and the prescribed torque. The appropriate torque depends on the dimension of the pressure connection and on the sealing element used (form/material). Do not use the case as working surface for screwing in or unscrewing the instrument.

When screwing the transmitter in, ensure that the threads are not jammed.

If necessary observe information about tapped holes and welding sockets.

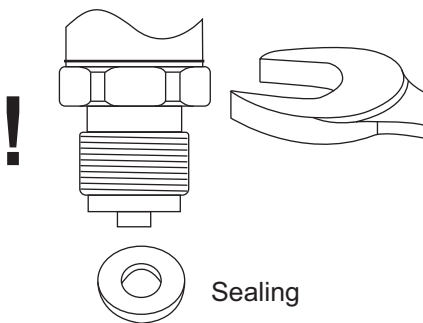

Sealing

4 Starting, operation (continued)

4.6 Electrical connection

Connect the instrument to earth via the pressure connection.



The ingress protection specified only apply while the pressure transmitter is connected with the female connectors that provide the corresponding ingress protection.

Ensure that the cable diameter you select fits to the cable gland of the connector. Ensure that the cable gland of the mounted connector is positioned correctly and that the sealings are available and undamaged. Tighten the threaded connection and check the correct position of the sealings to ensure ingress protection.

Make sure that the ends of cables with flying leads do not allow any ingress of moisture.

Route the cable without applying a force or turning moment to the device.

4.7 Pin assignment

Connection	Current loop 4...20 mA HART	
	U+	U-
M12, 4-pole	1	3
M12, 5-pole	1	3
M12, 8-pole	1	3
Super Seal, 3-pole	1	3
Deutsch DT04, 3-pole	A	B
Deutsch DT04, 4-pole	1	3

Connection	Current loop 4...20 mA HART	
	U+	U-
Bayonet DIN, 4-pole	1	2
Valve (L-plug), 4-pole	1	2
Cable, 4-pole	yellow	white
Cable, 6-pole	yellow	white
MIL, 6-pole	A	C

View: plug pins of male connector

M12, 4-pole	M12, 5-pole	M12, 8-pole	Super Seal, 3-pole	Deutsch DT04, 3-pole
Deutsch DT04, 4-pole	Bayonet DIN, 4-pole	Valve (L-plug), 4-pole	MIL, 6-pole	Cable, 4-, 6-pole
				LIYCY 4 or 6x0,25 mm ² grey

4.8 Example for connection

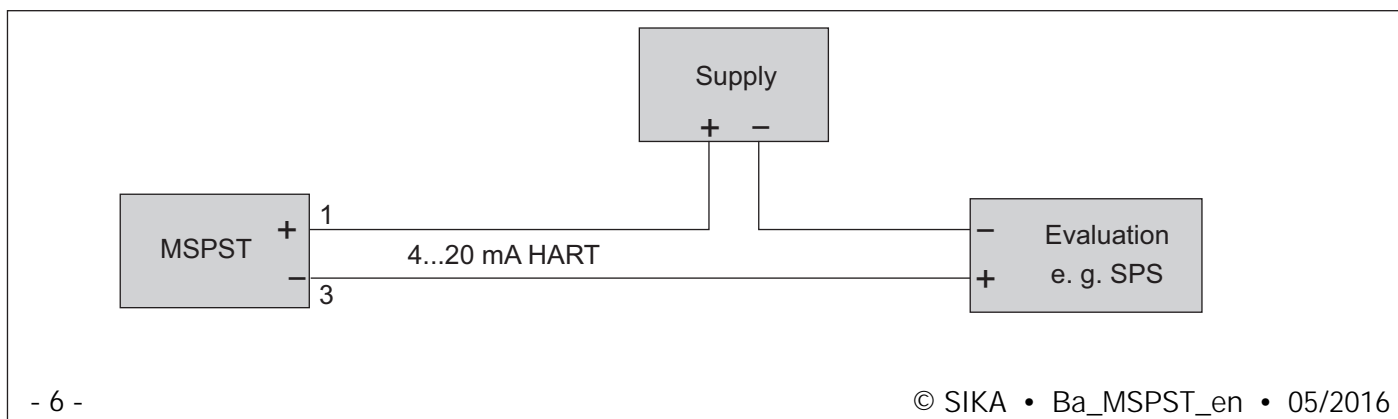

● 4 Starting, operation (continued)

4.9 Functional test



The output signal must be proportional to the pressure. If not, this might point to a damage of the diaphragm. In that case refer to chapter "Troubleshooting" (page 7).



Warning

- Open pressure connections only after the system is without pressure.
- Observe the ambient and working conditions outlined in chapter "Technical data" (page 8)
- Please make sure that the pressure transmitter is only used within the overload threshold limit at all times. (table page 8)
- When touching the transmitter, keep in mind that the surfaces of the instrument components might get hot during operation.

4.10 Error detection / Error current

The device detects wire break and short circuit (sensor element <> measuring amplifier) as well as pressures outside of the measuring range and indicates this with an error current in the current loop circuit.

The current output is proportional to the pressure from 3,8 to 20,5 mA. If the measured pressure would result in a current below 3,8 mA the current output is set to 3,6 mA (also for a wire short circuit). If the current would exceed 20,5 mA, the current output is set to 21 mA (also for wire break).

If the device is equipped with switching outputs, these will be disabled if an error is detected for more than 10 seconds. This ensures that the switches are in a safe state, comparable to the of voltage supply.

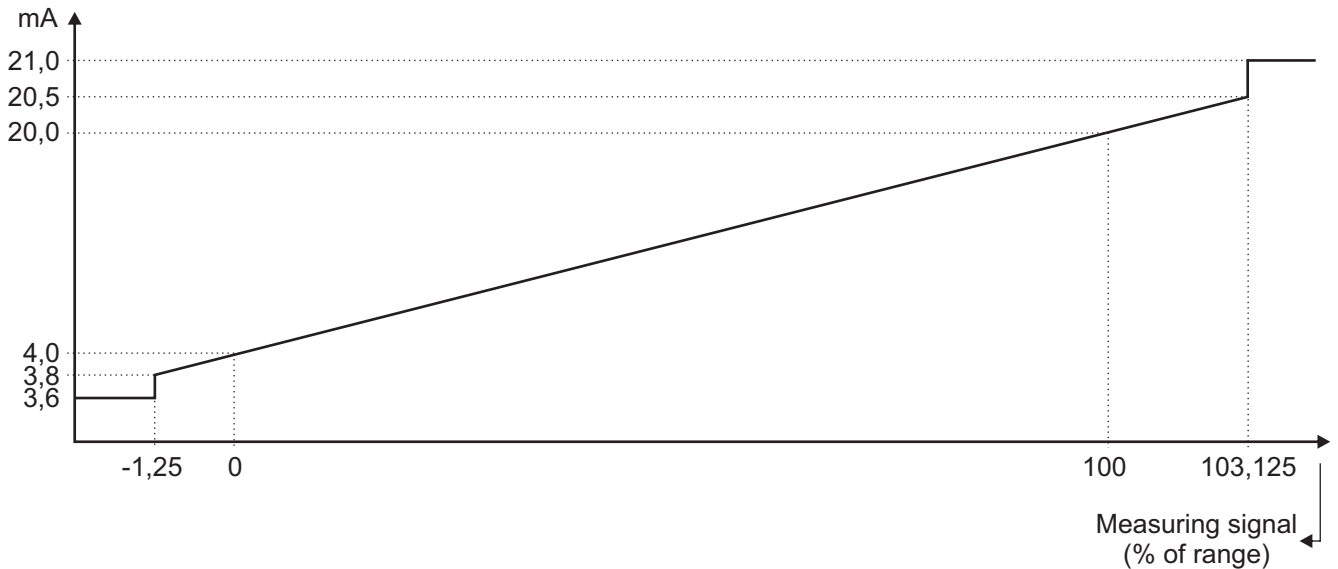

5 Troubleshooting



Warning

- Open pressure connections only after the system is without pressure.
 - Take precautions with regard to remaining media in removed pressure transmitters. Remaining media in the pressure port may be hazardous or toxic .
 - Remove the pressure sensor from service and mark it to prevent in from being used again accidentally, if it becomes damaged or unsafe for operation.
 - Have repairs performed by the manufacturer only.
-
- Do not insert any pointed or hard objects into the pressure port for cleaning to prevent damage to the diaphragm of the pressure connection.
 - Verify in advance if the pressure is being applied (valves / ball valve etc. open) and if the right voltage supply and the right type of wiring has been chosen.

Failure	Possible cause	Procedure
No output signal	Cable break No/incorrect voltage supply or current spike	Check connectors and cable Adjust voltage supply to correspond with the operating instructions
No/false output signal	Incorrectly wired	Follow pin assignment (see instrument label / operating instructions)
Output signal unchanged after change in pressure	Mechanical overload through overpressure	Replace instrument, if failure reoccurs consult the supplier
Signal span dropping off / too small	Mechanical overload through overpressure Diaphragm is damaged e. g. through impact, abrasive/aggressive media, corrosion of diaphragm/pressure connector, transmission fluid missing Seal/sealing face damaged/contaminated, seal mounted incorrectly, threads crossed	Replace instrument, if failure reoccurs consult the supplier Contact the supplier and replace the instrument Clean the seal/sealing face, possibly replace the seal
Signal span erratic/incorrect	Electromagnetic interference source in the vicinity e. g. inverter drive Working temperature too high/ too low Instrument not grounded Violent fluctuations in the process media pressure	Shield the device, shield the cables, remove the interference source Ensure permissible temperatures as per the operating instructions Ground instrument Damping, consult the supplier
Abnormal zero point signal	Working temperature too high/ too low Abnormal mounting position Overload limits exceeded	Ensure permissible temperatures as per the operating instructions Correct the zero point via software (teach lower range) Ensure permissible overload limits are observed (see operating instructions)

Note: In case of unjustified reclamation an additional charge is possible.

Make sure that after the setting the unit is working properly. In case the error continues to exist send the instrument for reparation (or replace the unit).

Returned goods: Purge / clean dismantled instruments before returning them in order to protect persons and the environment from any hazard caused by adherent remaining media.

● 6 Technical data

Input

Pressure: relative: 0...0,1 up to 0...1000 bar / -1...0 bar absolute: 0...0,25 up to 0...16 bar
 Pressure ranges: see table page 2 (with overpressure safety, burst pressure)

Output

Current signal: 4...20 mA with superimposed communication signal (HART), 2-wire current loop
 Current range: 3,8...20,5 mA
 Signal on error: 3,6 mA (sensor short circuit, underflow)
 21 mA (sensor break, sensor open circuit, overflow)

Performance

Sensor: Accuracy: <0,5% of span (at reference conditions)
 Including non-linearity, hysteresis, zero and full scale error (corresponds to error of measurement per IEC 61298-2)
 Adjustment: in vertical mounting position with lower pressure connection
 Non-linearity: <0,2% of span (BFSL per IEC 61298-2)
 Non-repeatability: <0,1% of span (per IEC 61298-2)
 1-year stability: <0,2% of span (at reference conditions)
 Temperature coefficient: mean coefficient (TC) within compensated temperature range
 TC zero: <0,2% of span / 10 K and <0,4% span / 10 K for ranges <250 mbar
 TC span: <0,2% span / 10 K
 Reference conditions: 15...25 °C / 860...1060 mbar / 45...75% rH / 24 VDC
 Measuring amplifier: Resolution: 16 Bit
 Accuracy: 0,3% of range
 Filter setting: 0...99 s
 Transmission behaviour: linear with pressure
 Measuring rate: 10 measurements / s
 Configuration: keys on display / via software (HART-communication)
 Turn-on delay time: <5 s
 Response time: 20 ms

Supply

Voltage: HART current loop: 12...40 VDC
 Load: $R = (U_B - 12 \text{ V}) / 21 \text{ mA}$
 Voltage reversal: Protection available (no function, no damage)

Ambient conditions

Temperature: Operating range: -20...80 °C 0...+80 °C (compensated range)
 Storing: -20...+85 °C Medium: -30...+100 °C
 Condensation: uncritical
 CE-conformity: Pressure equipment directive: 2014/68/EU EMC directive: 2014/30/EU
 Shock resistance: 1000 g according IEC 60068-2-27 (mechanical shock)
 Vibration resistance: 20 g according IEC 60068-2-6 (vibration under resonance)

Mechanics

Dimensions: see data sheet
 Pressure connection: G 1/2 (EN837) / G 1/4 (EN837) / G 1/4 (DIN 3852-E) / 1/2 NPT / 1/4 NPT
 for NPT thread: nominal size for "US standard tapered pipe thread NPT"
 Electrical connection: lateral Option: upwards
 Plugs and cables: see data sheet
 Material: Process connection: stainless steel CrNi (contact with medium)
 Body, Cover: PBT GF30
 Transmission fluid: synthetic oil (internal), no transmission fluids for models with pressure ranges >25 bar
 Weight: approx. 230 g
 Protection of device: Ingress protection: at least IP 65 (electronics)
 PCB: potted

Pressure table

Pressure range	0,1	0,16	0,25	0,4	0,6	1	1,6	2,5
Overpressure safety	1	1,5	2	2	4	5	10	10
Burst pressure	2	2	2,4	2,4	4,8	6	12	12
Pressure range	4	6	10	16	25	40	60	100
Overpressure safety	17	35	35	80	50	80	120	200
Burst pressure	20,5	42	42	96	96	400	550	800
Pressure range	160	250	400	600	1000			
Overpressure safety	320	500	800	1200	1500			
Burst pressure	1000	1200	1700	2400	3000			



Sensors and Measuring Instruments



Flow Measuring Instruments



Test and Calibration Instruments



SIKA Dr. Siebert & Kühn GmbH & Co. KG
Struthweg 7-9
D-34260 Kaufungen • Germany

 +49 (0)5605 803-0

 +49 (0)5605 803-54

 info@sika.net

 www.sika.net