



ModulSensor Level

Type MSLSD



● **Table of Contents**

1	General (1.1 For information / 1.2 Signs, abbreviations)	3
2	Transport, Packaging, Storage (2.1 Transport / 2.2 Packaging / 2.3 Storage)	3
3	For your safety	4
3.1	Intended use	4
3.2	Personnel qualification	4
3.3	Special hazards	4
4	Starting operation	5
4.1	Function	5
4.2	Before mounting	5
4.3	Product label (example)	5
4.4	Mechanical connection	5
4.5	Electrical connection	6
4.6	Pin assignment	7
4.7	Example for connection	7
4.8	Connecting the switching outputs	7
4.9	Functional test	8
4.10	Error detection / error current	8
4.11	Adjusting the display	8
5	Handling an configuration	9
5.1	System operating principles	9
5.2	Main menu	11
5.3	Basic menu	12
5.4	Display menu	14
5.5	Switch point menu	15
5.6	Calibration menu	18
5.7	System menu	19
5.8	Overview of the menu tree	20
6	Troubleshooting	21
7	Maintenance, Dismounting, Return, Cleaning, Disposal	22
8	Technical data	23
9	Dimensions	24

● 1 General

1.1 For Information

- These operation instructions contain important information on handling the level sensor. Working safely requires that all safety instructions and work instructions are observed .
- Skilled personnel must have carefully read and understood the operating instructions prior to beginning any work.
- The operating instructions are part of the product and must be kept in the immediate vicinity of the level sensor and readily accessible to skilled personnel at any time.
- Observe the relevant local accident prevention regulations and general safety regulations for the level sensor's range of use.
- If the serial number gets illegible (e. g. by mechanical damage), the retraceability of the instrument is not possible any more.
- The level sensors, described in this operating manual, are carefully designed and manufactured using state-of-the-art technology. Every component undergoes strict quality inspection in all stages of manufacture.
- The manufacturer's liability is void in the case of any damage caused by using the product contrary to its intended use, non-compliance with these operating instructions, unauthorised modifications to the level sensor or assignment of insufficiently qualified skilled personnel.

1.2 Signs, abbreviations



Warning!

A non-observance can cause injuries to persons and/or the demolition of the device. There can be a dangerous to life.



Attention!

A non-observance can cause a faulty operation of the device or lead to property damage.



Information!

A non-observance can have influence on the operation of the device or cause unintentional reactions of the device.



Danger!

When not observing the safety instructions, there is a risk of serious or fatal injuries caused by electrical power.



Warning!

Possibly a dangerous situation can occur, which results in burns because of hot surfaces or liquids, if not avoided.

- U+: Positive supply connection
 U-: Negative supply connection
 SP1: Switching point 1
 SP2: Switching point 2

● 2 Transport, Packaging, Storage

2.1 Transport

Check the instrument for any damage that may have been caused during transportation. If, report them immediately.

2.2 Packaging

Do not remove packaging until just before mounting. Keep the packaging as it will provide optimum protection during transport (e.g. change in installation site, sending back).

2.3 Storage

For longer term storage avoid the following influences:

- Direct sunlight or proximity to hot objects
- Mechanical vibration, mechanical shock (putting it hard down)
- Soot, vapour, dust and corrosive gases

If possible store the device in its original package or an equivalent one

● 3 For your safety



Warning

Before installation, commissioning and operation ensure that the appropriate level sensor has been selected in terms of measuring range, design, specific measuring conditions and appropriate wetted parts materials (corrosion).



More important safety instructions can be found in the individual chapters.

3.1 Intended use of the product

The level sensor MSLSD is used for the measurement of levels up to 2000 mm in not aggressive liquids. It can be used for pressures up to 25 bar.

The sensor has been designed and built solely for the intended use described here and may only be used accordingly.

The technical specifications contained in these operating instructions must be observed. Improper handling or operation of the instrument outside of its technical specifications requires the instrument to be taken out of service immediately and an inspection by the manufacturer.

When the instrument is transported from a cold into a warm environment, the formation of condensation may result in the instrument malfunctioning. Before putting it back into operation, wait for the instrument temperature and the room temperature to equalise.

The manufacturer shall not be liable for claims of any type based on operation contrary to the intended use.

3.2 Personnel qualification



Warning

Risk of injury if qualification is insufficient

Improper handling can result in considerable injury and damage to equipment.

- The activities described in these operating instructions may only be carried out by skilled personnel who have the qualifications described below.
- Keep unqualified personnel away from hazardous areas.

For installation and starting of the level sensor the personnel has to be familiar with the relevant regulations and directives of the country and must have the qualification required. They must have knowledge on measurement and control technology, have to be acquainted with electric circuits, are capable of carrying out the work described and can independently recognise potential hazards. Depending on the operation conditions of the application they have to have the corresponding knowledge, e.g. of aggressive media.

3.3 Special hazards



Warning

For hazardous media such as oxygen, acetylene, flammable or toxic gases or liquids, refrigeration plants, compressors, etc., in addition to all standard regulations, the appropriate existing codes or regulations must also be followed.

If you do not observe the appropriate regulation, serious injuries and/or damage can occur!



Warning

A protection from electrostatic discharge (ESD) is required.

The proper use of grounded work surfaces and personal wrist straps is required when working with exposed circuitry (PCB, printed circuit boards), in order to prevent static discharge from damaging sensitive electronic components.



Danger

There is a danger of death caused by electric current.

Upon contact with life parts, there is a direct danger of death.

Electrical instruments may only be installed and connected by skilled electrical personnel.

Operation using a defective power supply unit (e.g. short circuit from the mains voltage to the voltage output) can result in life-threatening voltages at the instrument.



Warning

Residual media in dismantled instruments can result in a risk to personnel, the environment and equipment. Take sufficient precautionary measures.

Do not use this instrument in safety or Emergency Stop devices. Incorrect use of the instrument can result in injury.

Should a failure occur, aggressive media with extremely high temperature and under high pressure or vacuum may be present at the instrument.

● 4 Starting, operation

4.1 Function

The MSLSD is fitted directly into the process via thread of the process connection. The float has a built-in magnet which has an effect on a measurement chain inside the tube. The output signal of the measurement chain is proportional to the level and is the input signal of the device's measuring amplifier.

4.2 Before mounting



Check if a completely assembled level sensor is supplied.

Inspect the level sensor for possible damage during transportation. Should there be any obvious damage, inform the transport company and supplier without delay.

Keep the packaging, as it offers optimal protection during transportation.

Ensure that the process connection thread and the connection contacts will not be damaged.

4.3 Product label (example)

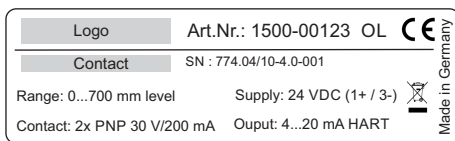

OH...:	Product code	Art.Nr.:	Part number
SN:	Serial number		
Range:	Measuring range		
Contact:	Limit value contact		
Supply:	Supply and connection		
Output:	Output signal		

4.4 Mechanical connection

Tools: wrench (flats 27)

The level sensors are designed for screw fitting directly into the process.

- The insertion length may reduce the maximum loading on the protecting tube.
- The medium may not have heavy pollution and not tend to crystallization.
- When mounting, take care of a proper vertical fitting position.
- Tighten the process connection with a suitable gasket.
- The level sensor may not be stressed by strong mechanical loads.
- Avoid the nearness of electromagnetic fields (malfunction).
- Long connection cables can cause malfunction by voltage peaks.
- It is recommended to use shielded connection cables (one side has to be grounded).

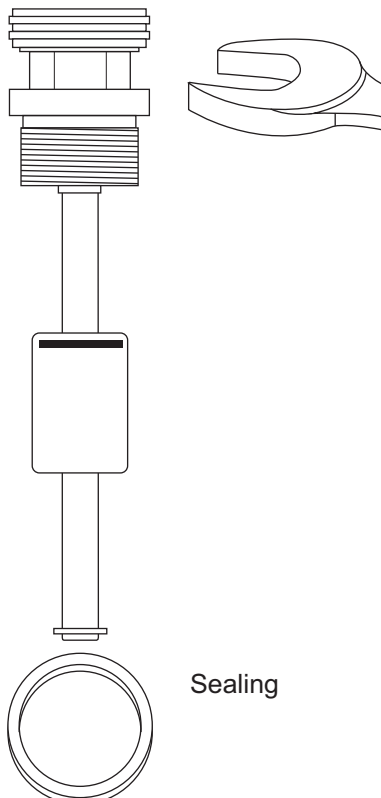

You have to provide for a sealing element which corresponds to the application.

Exceptions may be instruments with self-sealing threads (e. g. NPT thread).

When mounting the instrument, ensure that the sealing faces of the instrument and the measuring point are clean and undamaged.

Screw in or unscrew the instrument only via the flats using a suitable tool and the prescribed torque. The appropriate torque depends on the dimension of the process connection and on the sealing element used (form/material). Do not use the case as working surface for screwing in or unscrewing the instrument.

When screwing the transmitter in, ensure that the threads are not jammed.

If necessary observe information about tapped holes and welding sockets.

When the opening for mounting is smaller than the diameter of the float, the float has to be removed before mounting. Mark the direction of mounting on the float. After mounting the level sensor install the float inside the tank again.

● 4 Starting, operation (continued)

Example: Mounting of the level sensor

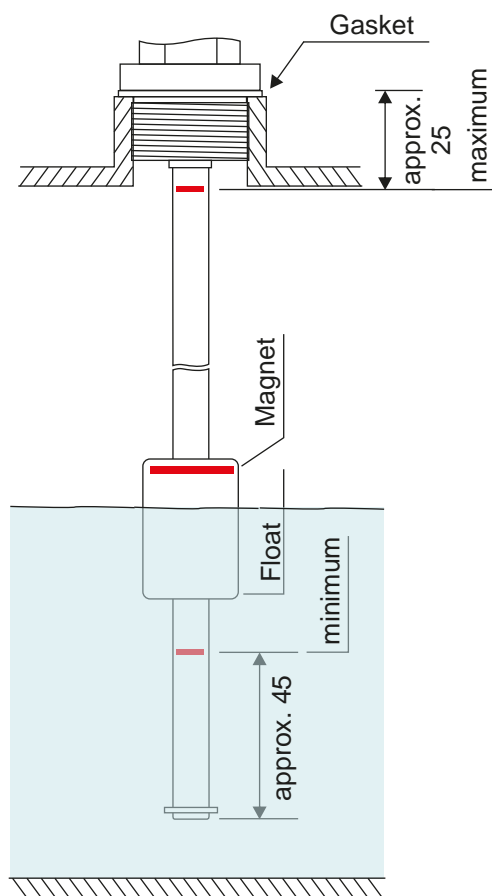

The devices are not suitable for liquids with a permanent turbulent surface and/or on vibrating machines.

4.5 Electrical connection

Connect the instrument to earth via the process connection.

! The ingress protection specified only apply while the level transmitter is connected with the female connectors that provide the corresponding ingress protection.

Ensure that the cable diameter you select fits to the cable gland of the connector. Ensure that the cable gland of the mounted connector is positioned correctly and that the sealings are available and undamaged. Tighten the threaded connection and check the correct position of the sealings to ensure ingress protection.

Make sure that the ends of cables with flying leads do not allow any ingress of moisture.

Route the cable without applying a force or turning moment to the device.

4 Starting, operation (continued)

4.6 Pin assignment

Connection	Current loop 4...20 mA HART		Limit value contact		
	U+	U-	Common	SP 1	SP 2
M12, 4-pole	1	3	2	4	
M12, 5-pole	1	3	5	4	2
M12, 8-pole	1	3	5	4	2
Super Seal, 3-pole	1	3			
Deutsch DT04, 3-pole	A	B			
Deutsch DT04, 4-pole	1	3	2	4	
Bayonet DIN, 4-pole	1	2	3	4	
Valve (L-plug), 4-pole	1	2	3	GND	
Cable, 4-pole	yellow	white	green	brown	
Cable, 6-pole	yellow	white	green	brown	grey
MIL, 6-pole	A	C	E	D	B

View: plug pins of male connector

M12, 4-pole	M12, 5-pole	M12, 8-pole	Super Seal, 3-pole	Deutsch DT04, 3-pole
Deutsch DT04, 4-pole	Bayonet DIN, 4-pole	Valve (L-plug), 4-pole	MIL, 6-pole	Cable, 4-, 6-pole
				LIYCY 4 or 6x0,25 mm ² grey

4.7 Example for connection

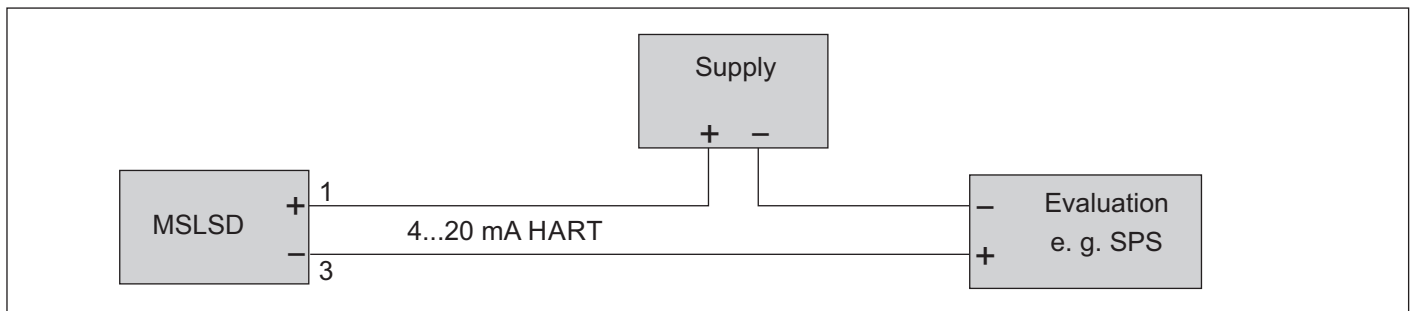

4.8 Connecting the switching outputs

The switching outputs are potential-free. They are electrically isolated from the current loop (see right).

In case of using only one switching point it is possible to connect the load on both sides of the contact, e.g. NPN-style: load connected to high or low side (see below).

Use an appropriate recovery diode if you want to switch inductive loads.

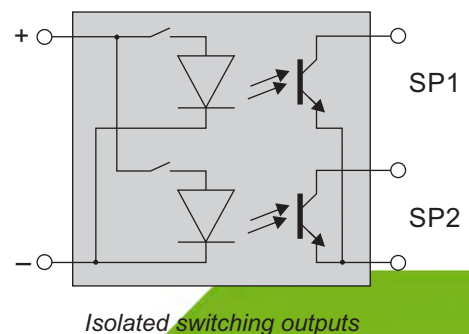

4 Starting, operation (continued)

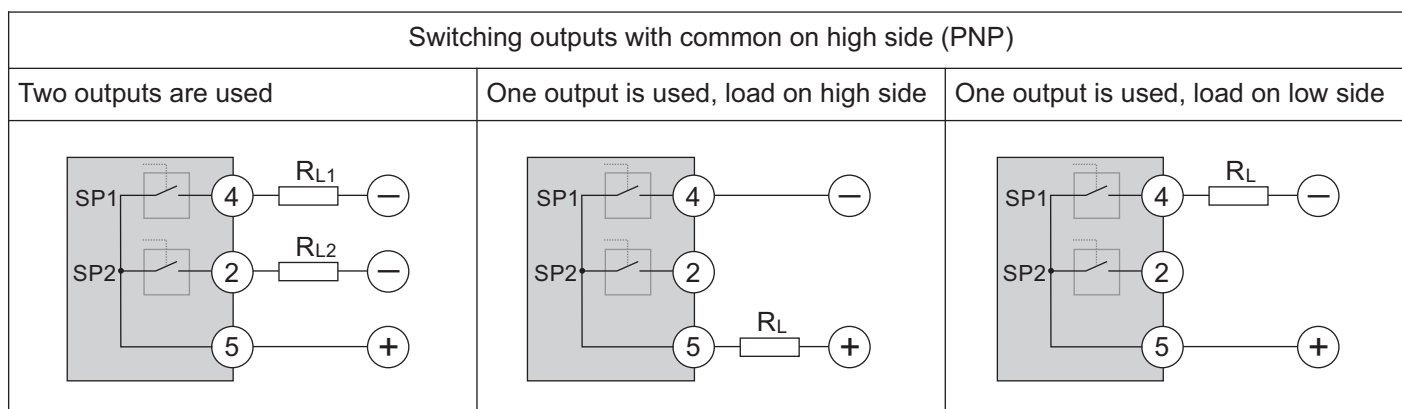
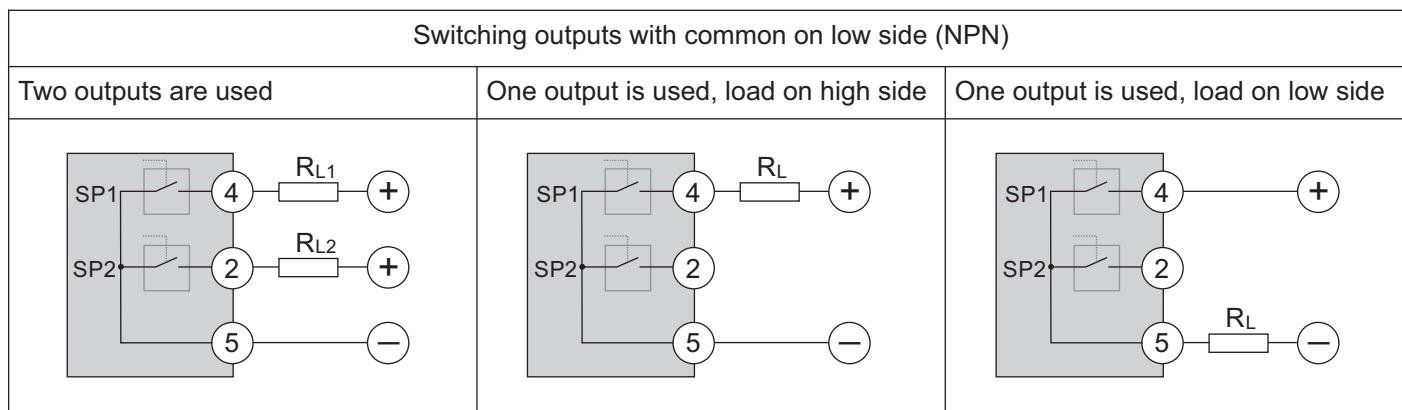

4.9 Functional test

i The output signal must be proportional to the level. If not, this might point to a damage of the sensor. In that case refer to chapter "Troubleshooting" (page 21).



Warning

- Open pressure connections only after the system is without pressure.
- Observe the ambient and working conditions outlined in chapter "Technical data" (page 23)
- When touching the transmitter, keep in mind that the surfaces of the instrument components might get hot during operation.

4.10 Error detection / Error current

The device detects wire break and short circuit (sensor element <> measuring amplifier) as well as levels outside of the measuring range and indicates this with an error current in the current loop circuit.

The current output is proportional to the level from 3,6 to 21 mA. If the measured level would result in a current below 3,6 mA the current output is set to 21 mA (also for a wire short circuit). If the current would exceed 21 mA, the current output is set to 21 mA (also for wire break).

If the device is equipped with switching outputs, these will be disabled if an error is detected for more than 10 seconds. This ensures that the switches are in a safe state, comparable to the of voltage supply.

4.11 Adjusting the display unit

It is possible to turn the display unit approx. 300° to optimize the reading. To do so, hold the plastic body with one hand and turn the display unit with the other hand into the wanted position.

The turning angle is limited by an internal limit stop. Do not try to force the display beyond that point. It might be destroyed.

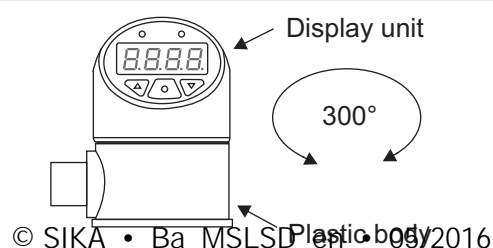

● 5 Handling and Configuration

Description of handling and configuration of the device with the three buttons on the head of display.

An overview of the menu tree is shown on page 20

The 3 buttons on the display head are working capacitive (no mechanical components), so there is no movement when pressing a button. The buttons are sensing the presence of a finger. Withdraw a finger at least 1 cm after pressing a button. This is useful for a proper detection of a keypress.

The following description is for the configuration with the three buttons. The configuration via HART communication modem is described in a separate manual.

5.1 System operating principles

5.1.1 System feedback to operator when buttons are pressed

The LEDs for switching output are used to give a feedback to operator when buttons are pressed. This does not affect the switching outputs themselves. When no button is pressed the LEDs are showing the state of switching outputs.

Button		Feedback
	Arrow button down (left)	Left LED is flashing
	Arrow button up (right)	Right LED is flashing
	Both arrow buttons simultaneously	Both LEDs are flashing
	Center button	Both LEDs are flashing rapidly

Feedback of the buttons

5.1.2 Display mode / Measured value indication

After power up the device starts in display mode. The current measured value is displayed or is displayed alternately with the unit (see 5.4.1).

The displayed value is flashing when the measured value is greater than the maximal presentable value. This can be caused by a fixed decimal point (see 5.4.3).

As long as the center button is pressed the selected unit will be displayed.

A single arrow button has no function in display mode.

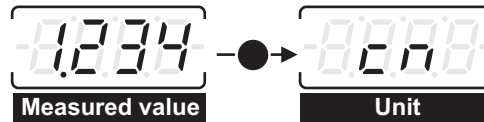

Indication of unit

5.1.3 Activating the configuration mode

When pressing both arrow keys simultaneously for at least 2 s the configuration mode is entered. The first entry of the operator menu appears on the display (bASE). If both buttons are not released within 4 s the device switches back to display mode, showing the current measured value again.

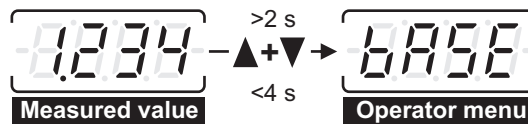

Activating the configuration mode

● 5 Handling and configuration (continued)

5.1.4 Configuration mode / Operator menu

The configuration mode always starts with the first item of the main menu (bASE). Within the menu you navigate with the arrow buttons. The center button selects a menu item respectively enters a submenu. Menu items which just show a value (e.g. maximum pointer) can be exit to the next upper menu item with the center button.

Every menu has the item „-ret-“ (return) which allows you to go back to the next upper menu. In the main menu it goes back to the display mode.

At the end of a menu (typically „-ret-“) you return to the first menu item when pressing the down arrow button again. Similarly, you jump to the end of the menu when pressing the up arrow in the first menu item.

In each menu item it is possible to return to the next upper menu by pressing both arrow buttons simultaneously. The feedback is a flashing „-ret-“. When doing this for more than 1 s, the device returns to display mode with the feedback of a flashing „-ESc-“ (escape).

If no button is pressed for 5 minutes in the configuration mode, the device automatically switches back to the display mode.

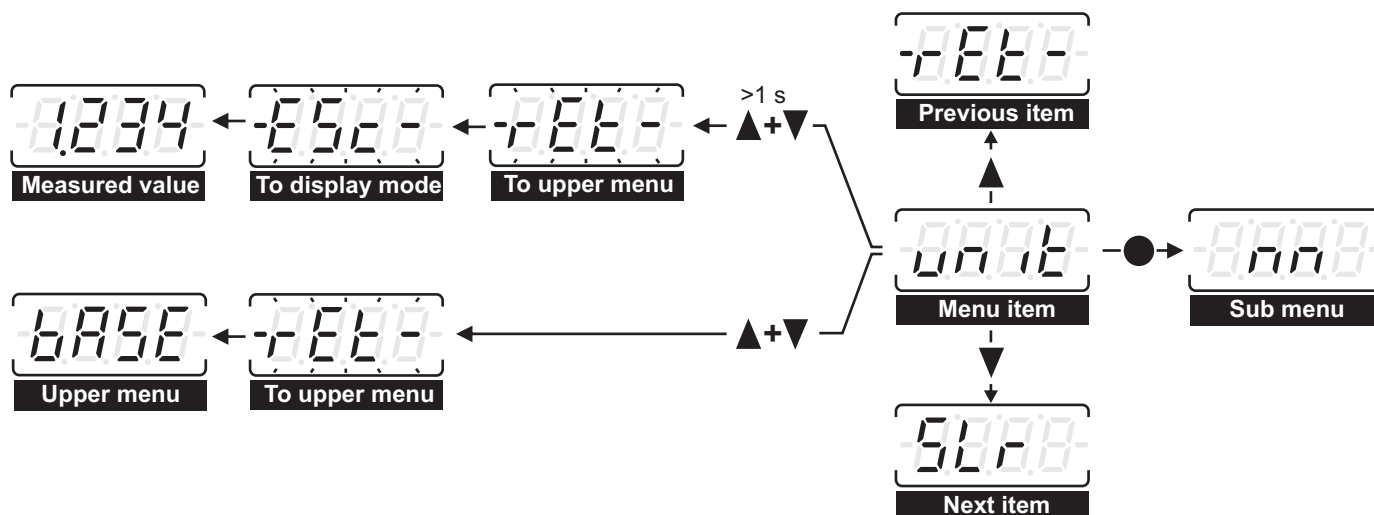

Configuration mode: Example operator menu

5.1.5 Setting values

There are 2 types of values that can be altered:

- values which can be selected from a predefined parameter list
- numerical values

Selecting a value from a list

Parameter lists are used for example for the units. Within the list you navigate with the arrow buttons. With the center button a selected value is stored, confirmed with indicating „Stor“. After that the device is in the next upper menu.

The list can be left by pressing both arrow buttons simultaneously to the next upper menu without changing the present value.

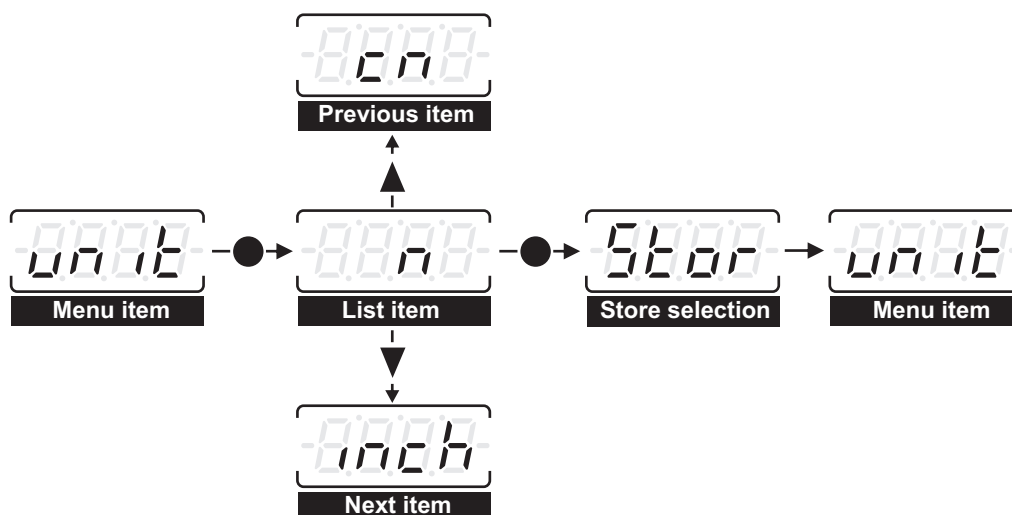

Configuration mode: Example to select a value from a list

5 Handling and configuration (continued)

Setting a numerical value

Numerical values are entered digit by digit. The selected digit flashes and is incremented with the up arrow button and decremented with the down arrow button. The more significant digit will also be incremented or decremented when stepping over zero. If a change of the active digit would exceed the allowable value (e.g. the lower or upper range limit) the allowable value will be shown. With the opposite arrow button you can return to the previous value.

The selected digit is confirmed with the center button and proceed to the next digit. You can cancel the value entry at any time by pressing both arrow buttons simultaneously. The device will then switch back to the corresponding menu entry. The partially edited value will not be saved.

When the right-most digit is selected, the center button confirms the whole value. "Stor" appears on the display to confirm that the value has been stored and the device switches back to the menu item for the value.

You can store a partially edited value at any digit position by holding the center button until "Stor" appears on the display (approx. 2 s).

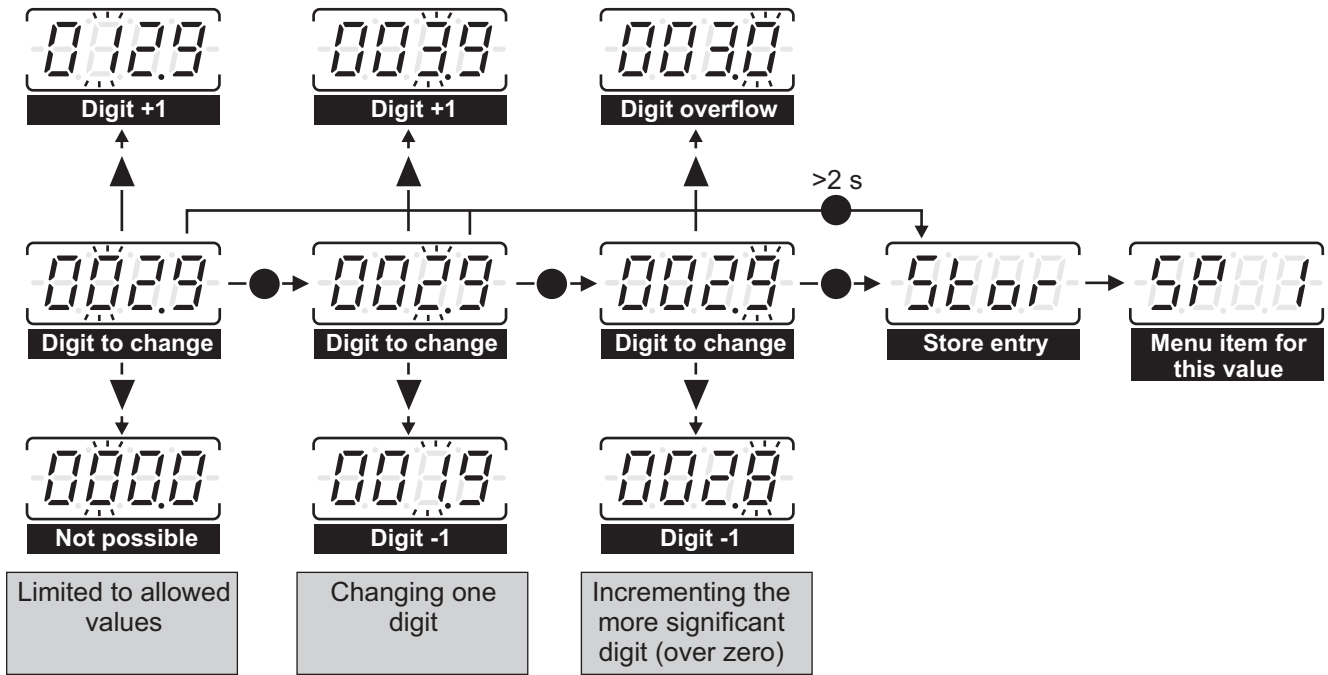

Button functions for entering numerical values (Example)

5.2 Main menu

The main menu has the following functions

Display	Designation	Description
BASE	Basic functions	Setting of unit, lower and upper range value, minimum and maximum pointer
DISP	Display functions	All settings relating to the display
SP	Switch point settings	Configuration of the switching outputs (option)
CAL	Calibration functions	Teaching lower and upper ranges, calibrating the current output
SYSD	System data	Reset to factory settings, loop test, Displaying of: hardware version, software version, serial number
RET	Return	Return to display mode

● 5 Handling and configuration (continued)

5.3 Basic menu (bASE)

The basic menu has the following functions

Display	Designation	Description
	Measuring unit	Setting the measuring unit (parameter list)
	Set lower range	Setting the temperature corresponding to 4 mA current signal
	Set upper range	Setting the temperature corresponding to 20 mA current signal
	Set damping	Setting the damping for the level signal
	Trailing pointer minimum (low)	Display and/or delete the minimum trailing pointer
	Trailing pointer maximum (high)	Display and/or delete the maximum trailing pointer
	Return	Return to main menu

5.3.1 Setting the measuring unit (unit)

A selected unit applies to data entries (e.g. switching points) and to the displaying of numerical values (e.g. the trailing pointers). Possible are the following units:

Display	Unit	Display	Unit
	mm		Foot
	cm		% of measuring range
	m		mA
	Inch		Return to „Unit“

Example for the needed steps for changing the unit from m to cm:

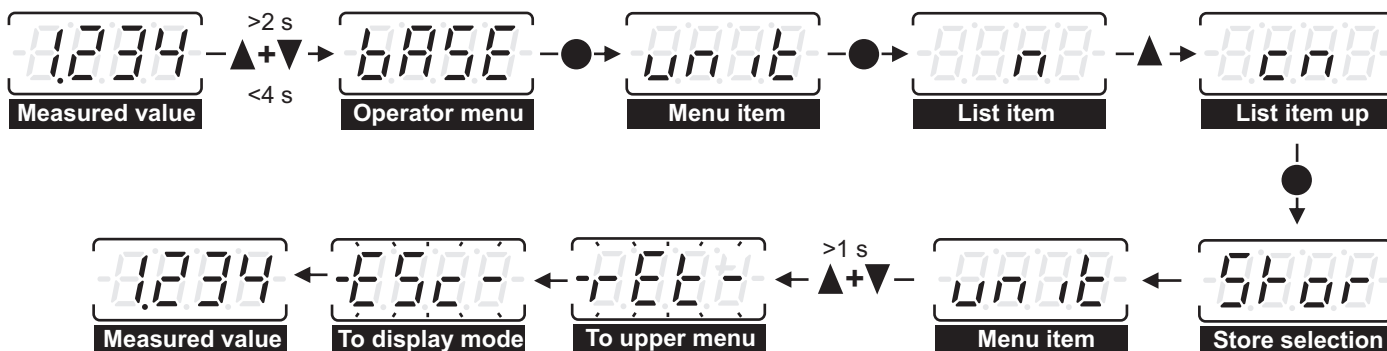

Steps to change the unit

5 Handling and configuration (continued)

5.3.2 Setting lower and upper ranges (SLr / Sur)

It is possible to set the lower range (SLr) and the upper range (Sur) value as needed within the allowed level range of the device (lower and upper range limit), which is also known as „turn down“. Make sure that there are no settings outside the permitted level range.

Select the desired menu item and then enter the level which has to correspond to 4 mA (SLr) or 20 mA (Sur) loop current. This will not affect the calibration of the transmitter and the current output.

A changing of the measuring range will delete the trailing pointers automatically.

This function is only available with the units mm, cm, m, Inch and Food.

Note: Although the switch points are set in the chosen unit, they are saved as a percentage of the range. Therefore the absolute switch point level will change with every new setting of the range. So it is always necessary to check the settings of the switch points after the setting of new range values.

5.3.3 Setting the damping (dAP)

The damping of the level can be set in intervals of 0.1 s. Damping is disabled with the setting 0.0 s. The default setting is 0.1 s.

The damping impacts current output and switch points equally.

5.3.4 Trailing pointers (Lo/Hi)

The trailing pointers for minimum and maximum values can be displayed or reset. A reset is confirmed with „----“ on the display.

The trailing pointer shows „Er.Lo“ respectively „Er.Hi“ if the current output has been set to an error current (see 4.10).

Display	Designation	Description
	Value of min/max pointer	Value of the min/max pointer in the selected measuring unit
	Clear	Reset the stored pointer value
	Return	Return to „Lo“ or „Hi“

The steps to reset the minimum pointer are shown below.

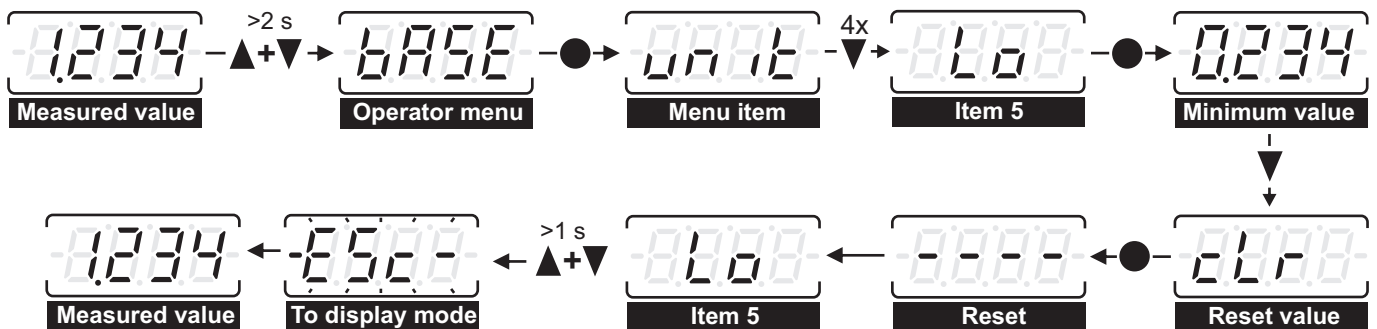

Steps to reset the minimum pointer

● 5 Handling and configuration (continued)

5.4 Display menu (diSP)

The display menu has the following functions

Display	Designation	Description
	Add unit	Adds the unit to the level on the display or removes it
	Display period for measured value (time data)	Setting between 0,5...99,9 s possible
	Display period for unit (time unit)	Setting between 0,0...99,9 s possible
	Rotate 180°	Rotate screen by 180° when the device is mounted upside down
	Decimal places	Setting the decimal places (0...3 fixed decimal places or automatic)
	Return	Return to „diSP“

5.4.1 Display option for measuring unit (AddU)

You can set the display to show level and unit simultaneously. When „on“ is selected, the menu items „td“ (display period for level and „tu“ (display period for unit) are hidden (see 7.4.2).

Display	Designation	Description
	Off	The unit will be displayed alternately with level
	On	Unit and level will be displayed simultaneously
	Return	Return to „AddU“

5.4.2 Display period for measured value/unit (td / tu)

The unit can be shown either by pressing the center button in display mode or alternately with the measured value. The display periods of measured value and unit can be configured independently of one another.

Setting the period for the unit to 0.0, only the measured value will be displayed.

5.4.3 Rotating the display by 180° (rot)

In case of mounting the device upside down, the 7-segment display and buttons can be rotated by 180° so that reading and operating are possible as is usual.

Display	Designation	Description
	Standard (0°)	
	Upside down (180°)	Display rotated by 180° for upside down operation
	Return	Return to „rot“

● 5 Handling and configuration (continued)

5.4.4 Decimal point setting (dEcP)

Possible is a fixed or an automatic positioning of the decimal point.

Display	Designation	Description
	Automatic	The decimal point is set so that all digits are fully used
	No decimal place	
	One decimal place	
	Two decimal places	
	Three decimal places	
	Return	Return to „dEcP“

Please note that when the decimal point is fixed the measured value may not be displayed if there are insufficient digits left of the decimal point. In this case the maximum number that can be shown on the display will appear flashing, e.g. "99.99", when two decimal places are set for a measured value of 110 cm.

If the "Add unit" function is enabled (see 5.4.1), the parameter list will be modified to reflect the available options for displaying measured value and unit simultaneously.

5.5 Switch point menu (SP)

The menu has items for the settings of the two switch points. The output behaviour can be a hysteresis or a frame function where the menu items are different. The switching delays can be defined independently from the output function.

Display	Designation	Description
	Switch point	Switch point in the selected measuring unit
	Reset point	Reset point in the selected unit
	Delay switch	Output delay at switch point
	Delay reset	Output delay at reset point
	Output function	Configuring the output behaviour (normally open, normally close, hysteresis / frame function)
	LED switch point	Configuring the behaviour of the LED for switch point (electrically, logically)
Menu items for switch point 2		
	Return	Return to „SP“

● 5 Handling and configuration (continued)

The switch point (SP) must be between the upper range value (URV) and the reset point. The reset point (rP) must be between the lower range value (LRV) and the switch point. The minimum hysteresis (difference between switch point and reset point) is 0,5% of the measuring range (MR) which is configured under 5.3.2.

It is possible to define a delay for the switch point as well as the reset point, e.g. to avoid that short temperature peaks trigger the switch.

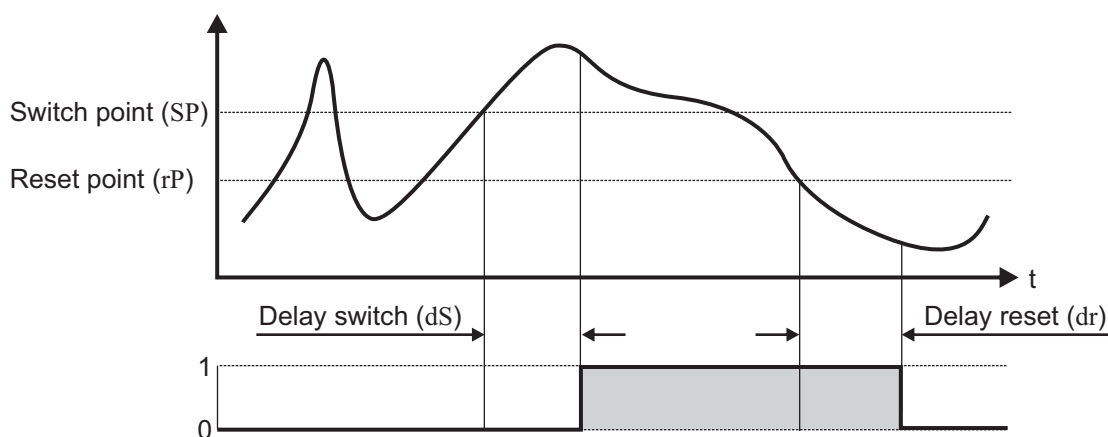
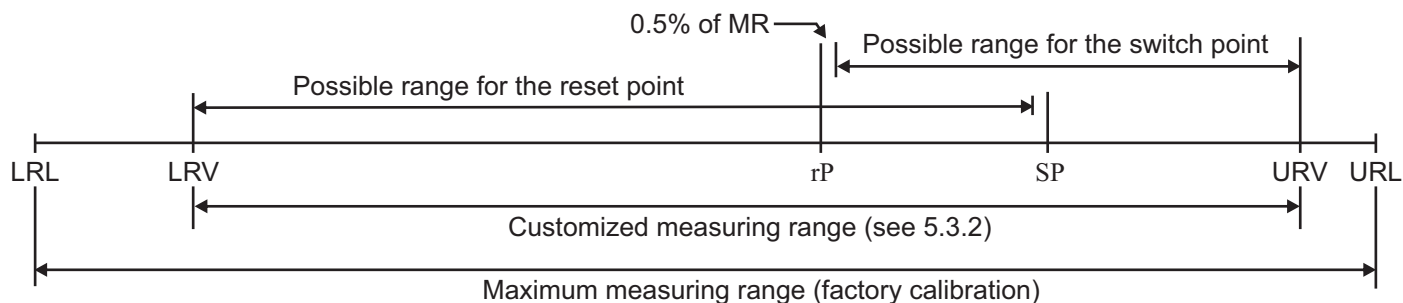

When the frame function is used, the menu items for switch point and reset point are replaced by the upper and lower frame limits. The minimum difference of the frame limits is 0,5% of the measuring range (MR) which is configured under 5.3.2.

Display	Designation	Description
	Frame high	Upper frame limit in the selected measuring unit
	Frame low	Lower frame limit in the selected measuring unit
	Delay switch	Output delay when entering the frame
	Delay reset	Output delay when leaving the frame
	Output function	Configuring the output behaviour (normally open, normally close, hysteresis / frame function)
	LED switch point	Configuring the behaviour of the LED for switch point (electrically, logically)
Menu items for switch point 2		
	Return	Return to „SP“

● 5 Handling and configuration (continued)

5.5.1 Configuring the output function (out 1 / 2)

Possible are hysteresis or frame functions and the output as normally open or closed contacts .

Display	Designation	Description
	Hysteresis, normally open	If the level is above the switch point the switch is closed. At the lower range limit the switch is open.
	Hysteresis, normally closed	If the level is above the switch point the switch is open. At the lower range limit the switch is closed.
	Frame, normally open	Inside of the frame the switch is closed. At the lower range limit the switch is open.
	Frame, normally closed	Inside of the frame the switch is open. At the lower range limit the switch is closed.
	Return	Return to „out 1" or „out 2"

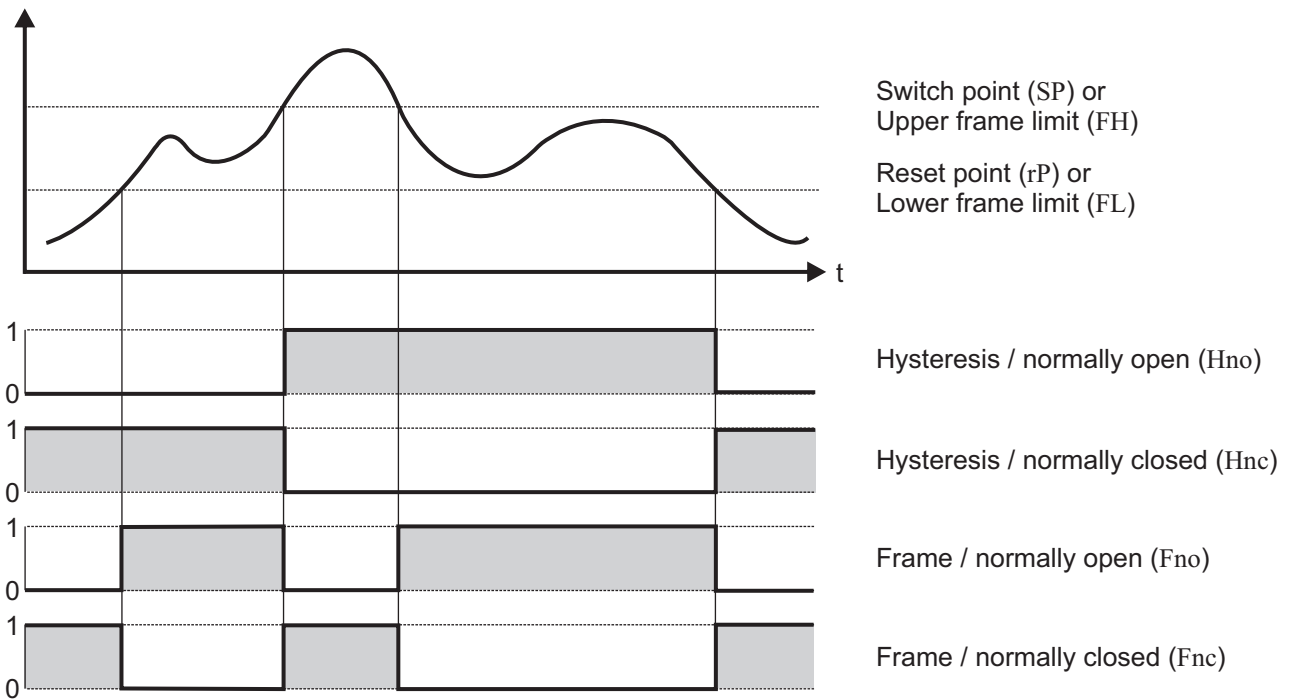

5.5.2 Configuring the behaviour of the LED switch point (LEd 1 / 2)

Possible is electrical or logical behaviour.

Display	Designation	Description
	Electrical behaviour	The LED is „ON" when the switch point contact is closed
	Logical behaviour	The LED is „ON" when the switch point value is reached or within frame
	Return	Return to „LEd 1" or „LEd 2"

● 5 Handling and configuration (continued)

5.6 Calibration menu (CAL)

The calibration menu has the following functions

Display	Designation	Description
	Teach lower range	Adjust the lower range (4 mA) to the applied level
	Teach upper range	Adjust the upper range (20 mA) to the applied level
	Adjust 4 mA	Adjust the current output at 4 mA
	Adjust 20 mA	Adjust the current output at 20 mA
	Return	Return to „CAL“

5.6.1 Adjusting lower and upper range (tLr/tur)

It is possible to adjust the output current for the lower range value (LRV) and the upper range value (URV) under the menu items „tLr“ and „tur“ to a certain pressure.

For the adjustment a stable level according the settings in chapter 5.3.2 has to be applied. Then enter the calibration menu and select „tLr“ respectively „tur“. When entering the menu the entry points to „rEt“. To confirm the applied level go to „YES“ with one of the arrow buttons and press the center button. After this final confirmation the applied level will be matched to the lower or upper range value.

Example: In chapter 5.3.2 the lower range value was set to 30 cm. Now apply 30 cm in the tank. When the display reading is stable go to the menu item „Teach Lower Range“ and confirm with „YES“. From now on the transmitter will regard the actual sensor element reading as 30 cm. The internal calculation of the level value out of the measured value will be adapted accordingly.

When confirming with the center button „donE“ appears on the display which confirms that the device has acknowledged the change. Then the device switches back to the initial menu item („tLr“ or „tur“).

Display	Designation	Description
	Return	Return to „tLr“ or „tur“
	Yes	Adjust the lower or upper range value to the applied pressure

5.6.2 Adjusting the current output (4 mA/20 mA)

It is possible to adjust the output current to eliminate tolerances and systematic deviations in the output driver or subsequent devices in the current loop.

Below are the steps for the lower current limit (4 mA). The adjusting of the upper current limit (20 mA) is done similar.

Select the menu item „4 mA“ and the device sets the output current to 4 mA. The display shows „04.00“. Now check the reading on the remote measuring instrument. If it deviates from 4 mA, enter this value in the device.





Example: The remote instrument shows 4.02 mA due to tolerances in the current loop. Enter then „04.02“ at the device.

If the value is confirmed the device will adjust the current output so that the remote instrument now will show 4.00 mA. The device will hold the 4 mA current output for 3 seconds so that it's possible to check the reading of the remote instrument. During this time the display will show „Stor“. After that period the device will calculate the current output depending on the measured level and switch back to the menu item „4 mA“.

● 5 Handling and configuration (continued)

5.7 System menu (SYS)

The system menu has the following functions

Display	Designation	Description
	Loop test	Setting a fixed current in order to test the current loop
	Information	Indicating of hardware and software version, serial number
	Reset	Reset to factory settings
	Return	Return to „SYS“







5.7.1 Loop test (LoOP)

The device can be used to test the current loop. For this the current output can be set to any value between 3.6...21 mA. When an entry is confirmed, the transmitter sets the output current to the selected value and displays this value flashing. The flashing shows that the displayed value is not a valid measurement.

Note: In this mode the device will not return to the display mode after 5 minutes but continue the test until the operator will stop it by pressing the center button or both arrow buttons. The device returns to the menu item „LoOP“ and the output current returns to the value which is corresponding to the measured pressure.

5.7.2 Information (inFo)

The information menu has the following functions



Display	Designation	Display	Designation
	Hardware version 1 (HW1)		Software version 2 (SW2)
	Hardware version 2 (HW2)		Serial number 1 (Sn 1)
	Software version 1 (SW1)		Serial number 2 (Sn 2)
	Return	Return to „InFo“	

Due to the limited number of alphanumerical segments on the display the values for these items are split.

5.7.3 Reset to factory settings (rES)

It is possible to reset the device to the configuration as delivered with the menu item „Reset“ (rES). When entering the menu the entry points to „rEt“. To confirm the reset go to „YES“ with one of the arrow buttons and press the center button. After this final confirmation all parameters will be changed to the settings as delivered.

When confirming with the center button „donE“ appears on the display which confirms that the device has been reset to factory settings. Then the device switches back to the initial menu item („rES“).

Display	Designation	Description
	Return	Return to „rES“
	Yes	Resetting the device to factory settings

5 Handling and configuration (continued)

5.8 Overview of the menu tree

BASE

unit
SLr
SUR
dAP
Lo
Hi

Menu with basic functions

Setting the measuring unit (mm, cm, m, Inch, Food, %, mA)

Setting the level (LRV) that corresponds to 4 mA output signal (only for mm, cm, m, Inch, Food)

Setting the level (URV) that corresponds to 20 mA output signal (only for mm, cm, m, Inch, Food)

Setting the damping for the measuring signal

Display and/or delete the minimum trailing pointer

Display and/or delete the maximum trailing pointer

disP

AddU
td
tu
rot
decP

All settings relating to the display

Enable or disable displaying unit and level simultaneously

Setting the display period for the measured value (only when „AddU“ is disabled)

Setting the display period for the unit (only when „AddU“ is disabled)

Display direction (0° = standard, 180° = turned)

Display the decimal places (0...3 fixed decimal places or automatically)

SP

SP 1 FH 1
rP 1 FL 1
ds 1
dr 1
out 1
LED 1

Configuring the switching outputs (when available)

Switch point or upper frame limit of switching output 1

Reset point or lower frame limit of switching output 1

Output delay at the switch point of switching output 1

Output delay at the reset point of switching output 1

Output functions of switching output 1 (Hno, Hnc, Fno, Fnc)

Behaviour LED switch point

Menu items for switch point 2

CAL

ELr
EUR
4mA
20mA

Calibration menu

Adjusting lower range value (4 mA) to the applied level

Adjusting upper range value (20 mA) to the applied level

Adjusting the current output at 4 mA

Adjusting the current output at 20 mA

SYS

LoopP
info
rES

System functions

Setting a fixed current for test of the loop

Versions of hardware and software, serial number

Reset to factory settings

● 6 Troubleshooting



Warning

- Open connections only after the system is without pressure.
- Residual media in dismantled instruments can result in a risk to personnel, the environment and equipment
- Remove the level sensor from service and mark it to prevent it from being used again accidentally, if it becomes damaged or unsafe for operation.

Failure	Possible cause	Procedure
No output signal, no indication	Cable break No supply voltage	Check connectors and cable Check wiring/supply
No/false output signal	Incorrectly wired	Follow pin assignment (see instrument label / operating instructions)
Erroneous measured values	Surface of medium is too turbulent Configuration of the sensor is not proper	Choose a suitable location of installation for the sensor Check configuration and adjust
Erroneous measured values (too low)	Float hangs or doesn't slide proper	Clean tube/float, check the medium for pollution
Erroneous measured values and response time too long	Wrong mounting geometry, e.g. mounting is not vertical Deposits on the sensor	Mount the sensor vertically Remove deposits
Measurement signal „comes and goes“	Cable break in connecting cable or loose contact caused by mechanical overload	Replace the sensor with a suitable design, e.g. thicker conductor cross section
Corrosion	Composition of medium not as expected or modified or wrong material of protecting tube	The sensor is not suitable for this application
Signal interference	Stray currents caused by electric fields or earth loops Earth circuits	Use of screened connecting cables, increase the distance to motors and power lines Elimination of potentials, use of supply isolators or galvanically isolated measuring amplifiers

Note: In case of unjustified reclamation an additional charge is possible.

● 7 Maintenance, Dismounting, Return, Cleaning, Disposal

7.1 Maintenance

The level sensors MSLSD require no maintenance and contain no components which could be repaired or replaced.

7.2 Dismounting



Warning

Residual media in dismantled instruments can result in a risk of personnel, the environment and equipment. Take sufficient precautionary measures.



Warning

There is a risk of burns. Let the instrument cool down sufficiently before dismantling. During dismantling there is a risk of dangerously hot pressure media escaping. Only disconnect the level sensor once the system has been depressurised.

7.3 Return



Warning

Before the return of an instrument see chapter 7.4.

When returning the instrument, use the original packaging or a suitable package.

To avoid a damage, use for example antistatic plastic film, shock-absorbent material, a marking as highly sensitive measuring instrument.

7.4 Cleaning



- Before cleaning the instrument disconnect the electrical connection.
- Clean the instrument with a moist cloth.
- Electrical connections must not come into contact with moisture.
- Wash or clean the dismantled instrument before returning it in order to protect personnel and the environment from exposure to residual media.
- Residual media in dismantled instruments can result in a risk to persons, the environment and equipment. Take sufficient precautionary measures.

7.5 Disposal



Dispose instrument components and packaging materials in accordance with the respective waste treatment and disposal regulations of the region or country to which the sensor is supplied

● 8 Technical data

Input

Level: 100...2000 mm
Medium: non aggressive fluids

Output

Current signal: 4...20 mA with superimposed communication signal (HART), 2-wire current loop
Current range: 3,8...20,5 mA
Signal on error: 3,6 mA (sensor short circuit, underflow)
21 mA (sensor break, sensor open circuit, overflow)

Performance

Sensor: Resolution: 4,5 mm,
Hysteresis: ca. 3mm
Measuring amplifier: Accuracy: 0,3% of range
Resolution: 16 Bit
Filter setting: 0...99 s
Transmission behaviour: linear with level
Measuring rate: 10 measurements / s
Configuration: keys on display / via software (HART-communication)
Turn-on delay time: <5 s
Response time: 20 ms
Indicator / limit values: Resolution: -9999...9999 digit
Error of measurement: $\pm 0,2\%$ of range, ± 1 digit
Temperature drift: 100 ppm/K
Features, operation: according VDMA 24574-1 up to 24574-4

Programmable features

Measuring amplifier: measuring range start / measuring range end / filter
Display: range of indication / time of indication / decimal point / units / stabilisation of zero point / locking of programming / calibration points / TAG number
Limit value contacts: limit value 1 and 2 / hysteresis 1 and 2 / delay times 1 and 2

Indication

Display: 7 segment, 8,5 mm, red, 4 digits, representation mirror-inverted 180° possible
Head of display: rotatable approx. 330°
Memory: minimum / maximum values
Indication: - measuring value - unit of measurement - control menu
Decimal point: automatically or manually, dependent on measuring range / unit
Representation: xxxx / xxx.x / xx.xx / x.xxx

Limit contacts

Electronically: 2x NPN or PNP (30 VDC, 200 mA)
Option: 2x NPN or PNP (30 VDC, 1000 mA)
Indication: 1 LED red for each limit value
Voltage across: <1 V
Settings: with 3 keys (TouchM-Technology)
Setting range: switch point and hysteresis: any value within measuring range
Switching delay: 0,0...999,9 s
Failsafe function: adjustable
Galvanical insulation: switching outputs are separated from measuring amplifier

Supply

Voltage: HART current loop: 12...40 VDC
Load: $R = (U_B - 12 \text{ V}) / 22 \text{ mA}$
Reverse battery protection: available (no function, no damage)

Ambient conditions

Temperature: Operating range: -20...+80 °C
Storing: -20...+85 °C
Medium: 0...+100 °C
Condensation: uncritical

8 Technical data (continued)

Mechanics

Dimensions:	see page 3
Process connection:	3/4" / 1" / 1,5" / 1"NPT (adaptor)
System pressure:	25 bar
Electrical connection:	see page 3
Material:	Protecting tube: stainless steel 1.4571
	Float: PE Ø24 (density medium: 1 or more)
	PE Ø29
	Option: stainless steel Ø29 (1.4571)
	Adaptor: stainless steel 1.4571
	Process connection: stainless steel 1.4571
	Body: PBT GF30
	Head of display: polycarbonate
Weight:	approx. 200 g (300 mm, 1", M12)
Fitting position:	vertical
System pressure:	PN 25
Protection of device:	Ingress protection: at least IP 65 (electronics)
	IP68 (sensor)
	PCB: potted

9 Dimensions (in mm)

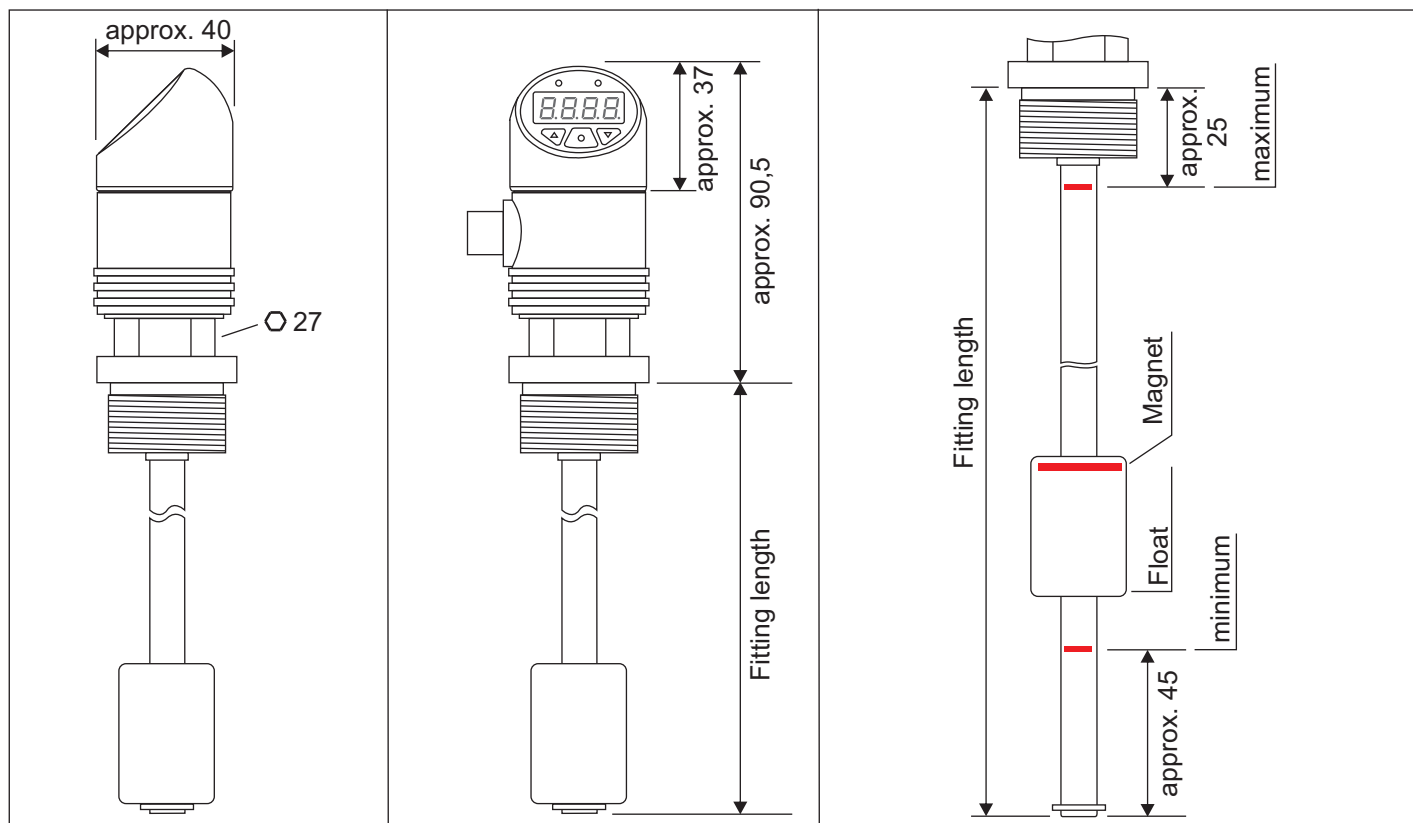



Sensors and Measuring Instruments



Flow Measuring Instruments



Test and Calibration Instruments



SIKA Dr. Siebert & Kühn GmbH & Co. KG
Struthweg 7-9
D-34260 Kaufungen • Germany

 +49 (0)5605 803-0

 +49 (0)5605 803-54

 info@sika.net

 www.sika.net